

M-710iC/50T (Top mount)



Max. load capacity
at wrist: **50 kg**



Max. reach:
1900 mm

Controlled axes	Repeatability (mm)	Mechanical weight (kg)	Motion range (°)						Maximum speed (°/s)						J4 Moment/ Inertia (Nm/kgm ²)	J5 Moment/ Inertia (Nm/kgm ²)	J6 Moment/ Inertia (Nm/kgm ²)
			J1	J2	J3	J4	J5	J6	J1	J2	J3	J4	J5	J6			
6	± 0.07	410	*1	261	491	720	250	720	*1	175	175	250	250	355	206/28	206/28	127/11

Working range

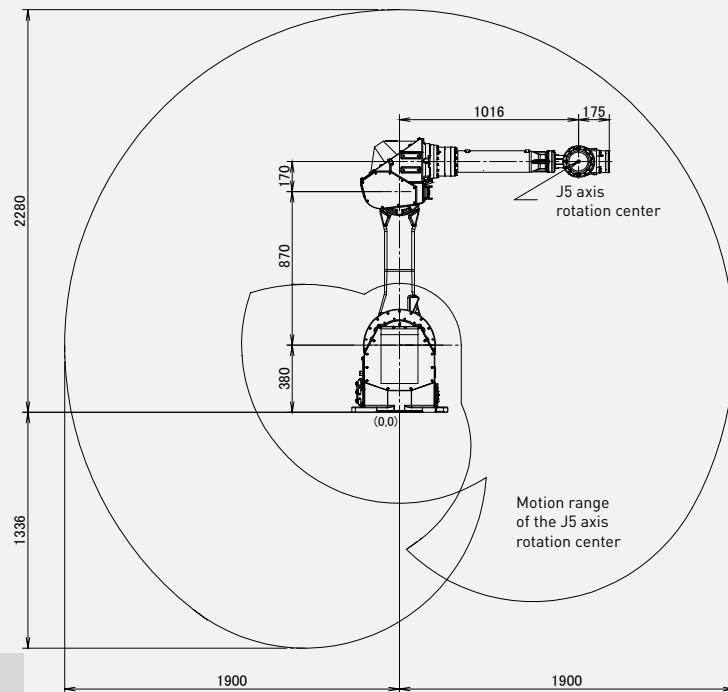
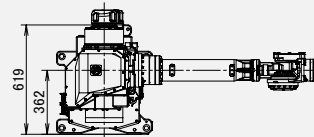

Motion range may be restricted according to the mounting angle!

Robot

	M-710iC/50T
Robot footprint [mm]	619 X 545
Mounting position Floor	●
Mounting position Upside down	●
Mounting position Angle	●

Controller

	R-30iB Plus
Open air cabinet	-
Mate cabinet	○
A-cabinet	●
B-cabinet	○
iPendant Touch	●

Electrical connections

Voltage 50/60Hz 3phase [V]	380-575
Voltage 50/60Hz 1phase [V]	-
Average power consumption [kW]	2.5

Integrated services

Integrated signals on upper arm In/Out	8/8
Integrated air supply	1

Environment

Acoustic noise level [dB]	71.3
Ambient temperature [° C]	0-45

Protection

Body standard/optional	IP54/IP67
Wrist & J3 arm standard/optional	IP67

*1) depending on rail specification

● standard ○ on request - not available () with hardware and/or software option